



Change in Saudi Arabia's TVET System

The Technical Trainers College (TTC): A center of change

Dr. Michael Klees, Dean
November 20th, 2013

Speech at



A Institution for



A Project of



Content

- Saudi Arabia's Vocational Training System – Basics
- Changes in the System
- TTC's Hub Role

Saudi Arabia age pyramid

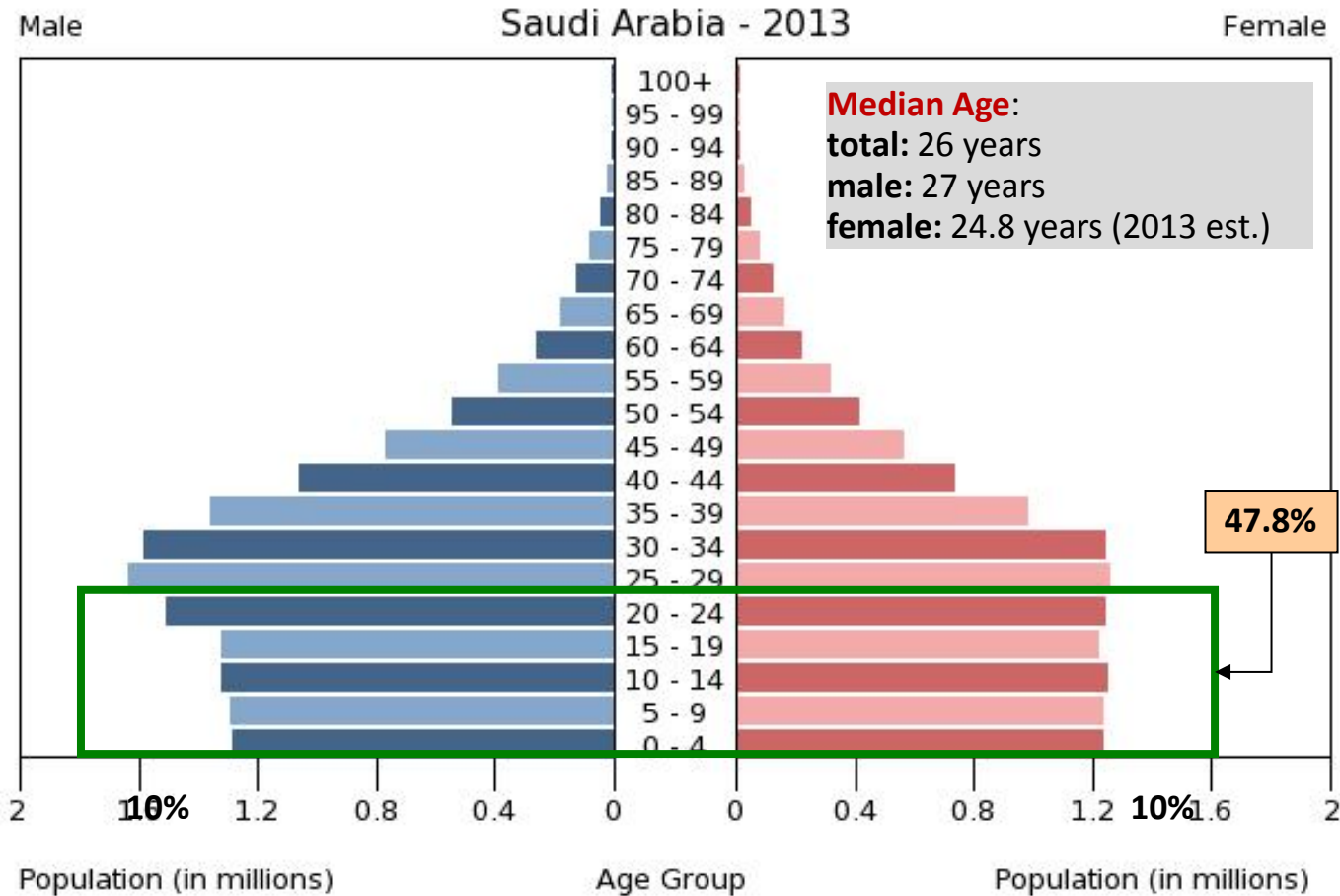

KSA TVET Key Parameters

- Unemployment rate in the group of 15-24 old people – **total: 28.2% (2008)**
 - **male: 23.6%**
 - **female: 45.8%**

44% of all unemployed people in KSA

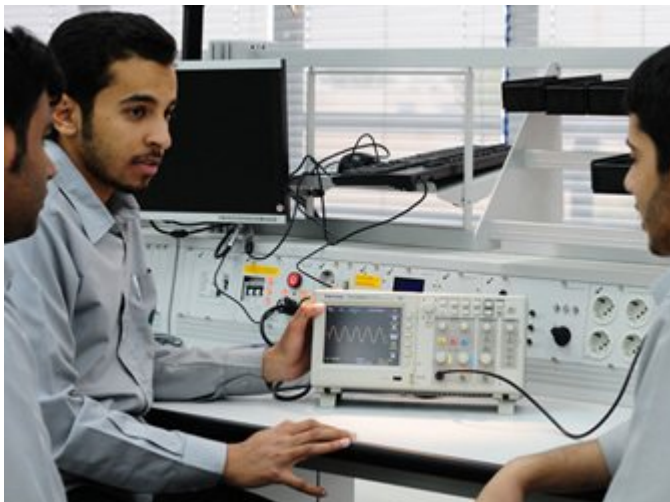

Number of TVET Students (2007)

- 33 Technical Colleges – 39.500 trainees
- 33 Vocational Training Institutes – 13.100 trainees
- 47 Vocational Training Centers – 13.900 scholars
- 70.800 scholars in the private sector

- **In total: 66.500** young people or 1.1% of the group 15-24
Germany (2012): 29.4% of the group 15-24

Saudi Arabia: Basic Information

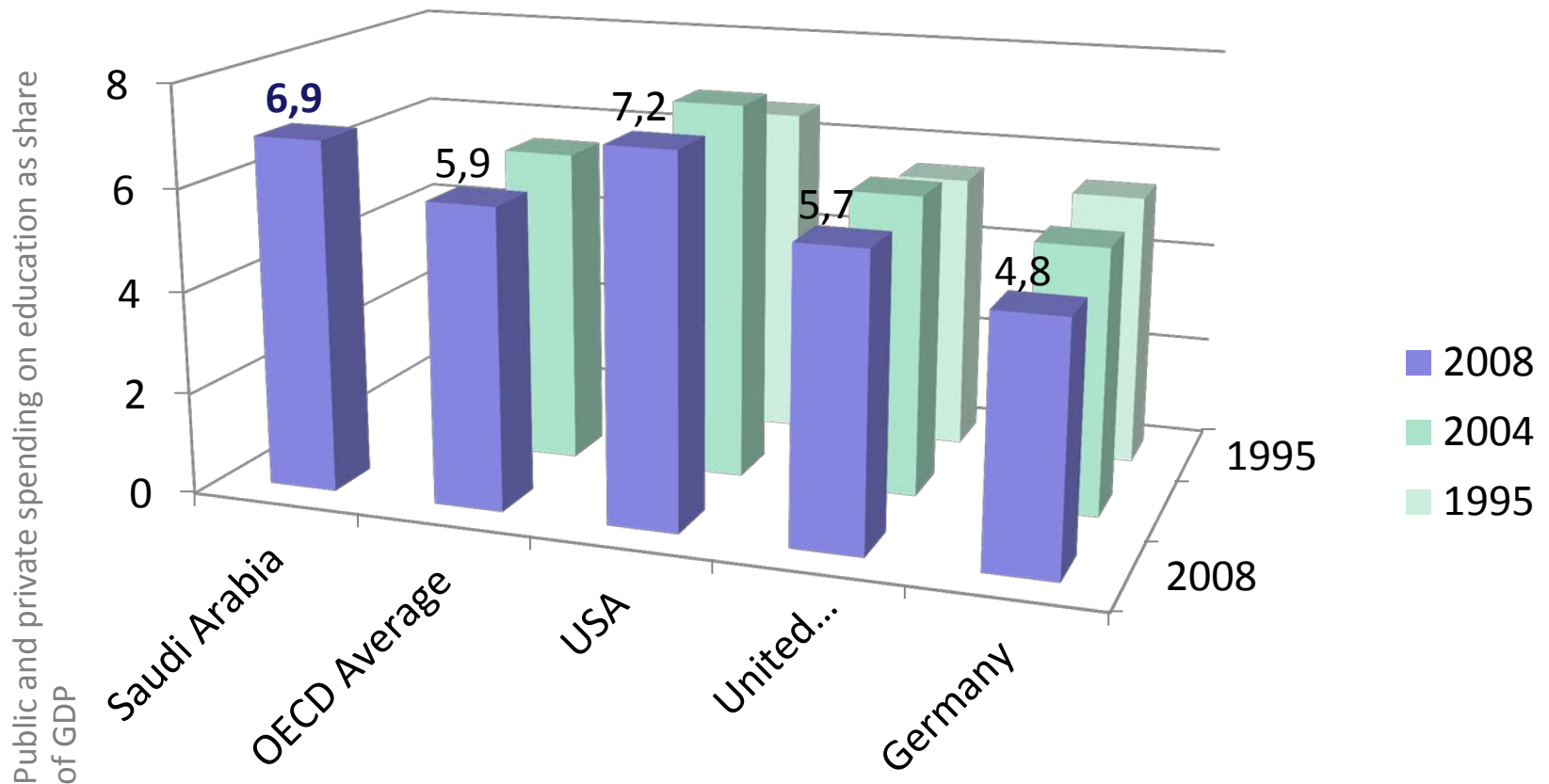

KSA spends more on education than the OECD

...and where the investment goes....TVET

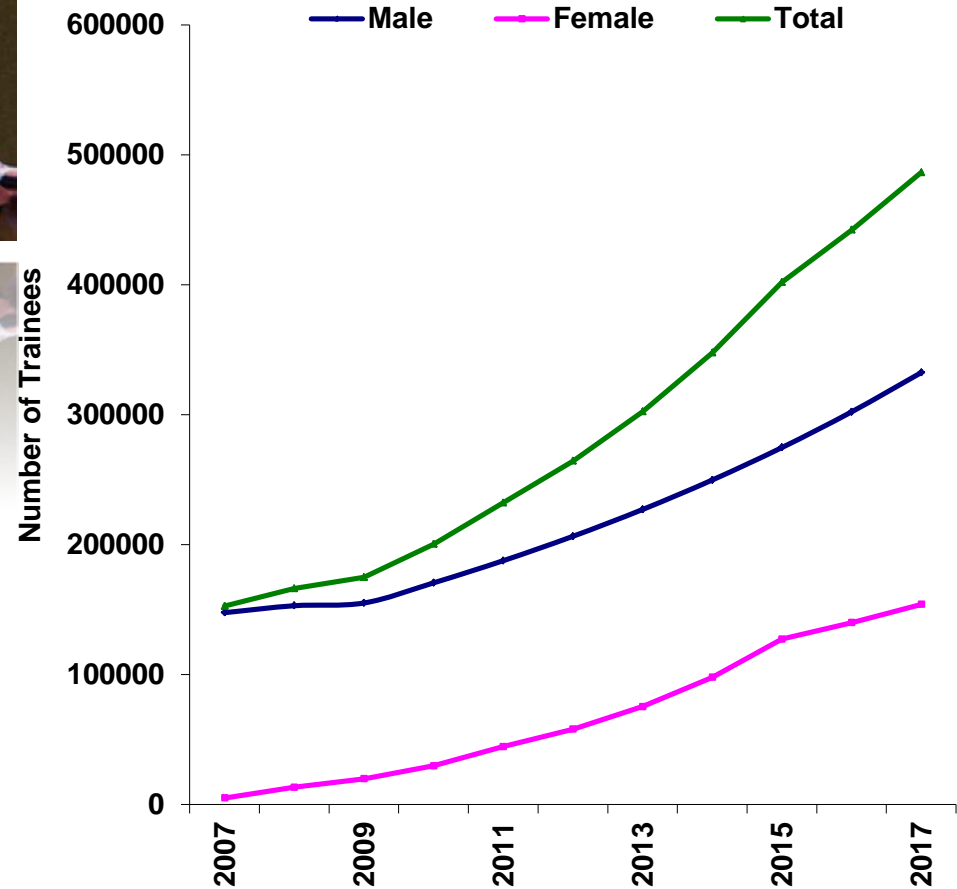
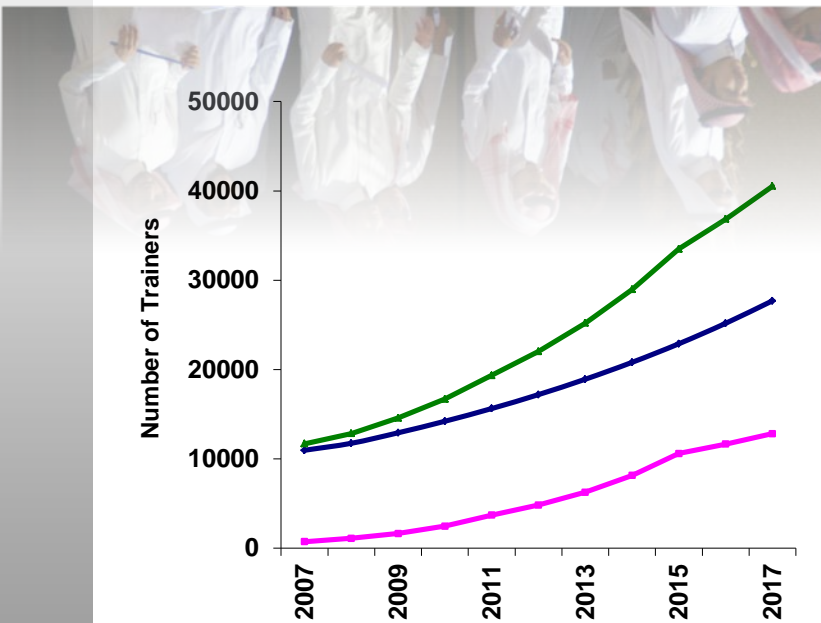

Dr. Michael Klees

50 New Colleges of Technology (Male) 50 Higher Institutes of Technology (Female)
 2 Trainers Training Colleges (Male) 2 Trainers Training Colleges (Female)
 162 New Industrial Secondary Institutes

Education System in Saudi Arabia

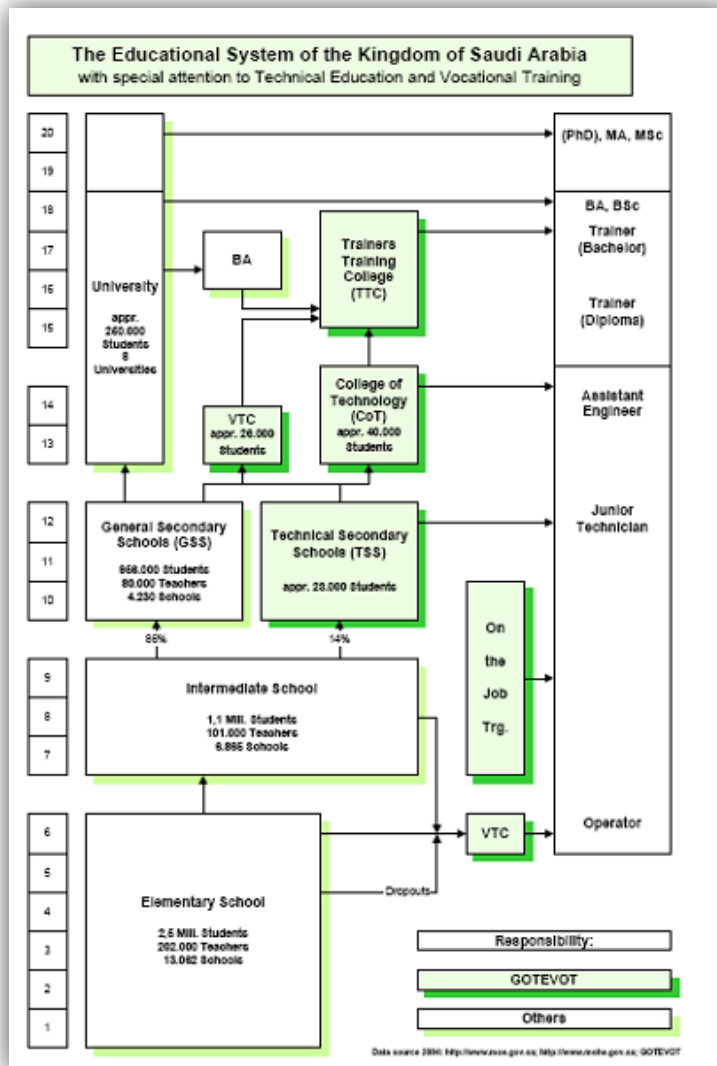

- Public Education is open for every Saudi National (man & woman) from primary schools to higher education
- Education system in Saudi Arabia is primarily under the jurisdiction of the *Ministry of Education*, the *Ministry of Higher Education and Technical & Vocational Training Cooperation* under the power of *Ministry of Labor* – with *King Saud University KSA* founded the *first university of the Arabian Peninsula*
- **2007**: 1,013,074 students (541,849 male and 471,225 female) with 87,823 teachers (41,108 male and 46,715 female)

Content

- Saudi Arabian's Vocational Training System – Basics
- Changes in the System
- TTC's Hub Role

Vocational Training in Saudi Arabia – until 2009



Colleges of Technology

Train new employees for industry



33 Colleges of Technologies for Males and some Colleges for Females abroad the Kingdom

Trainers came from outside KSA or with an non pedagogic background – **Trained by Training**

Vocational Training in Saudi Arabia – 2009-2013



Responsibility

Stepstone 2009: TTC was founded as KSA in/country facility to teach vocational trainers, based on German vocational training standards



Colleges of Technology

Train new employees for industry



كلية المدربين التقنيين
Technical Trainers College

Graduates from 6 CoT's study at TTC to become a Vocational Teacher

Best Graduates go to TTC

TTC graduates become Trainer at CoT's

Stepstone 2012: First 200 TTC graduates enter TVTC's vocational training system

Vocational Training in Saudi Arabia - 2013

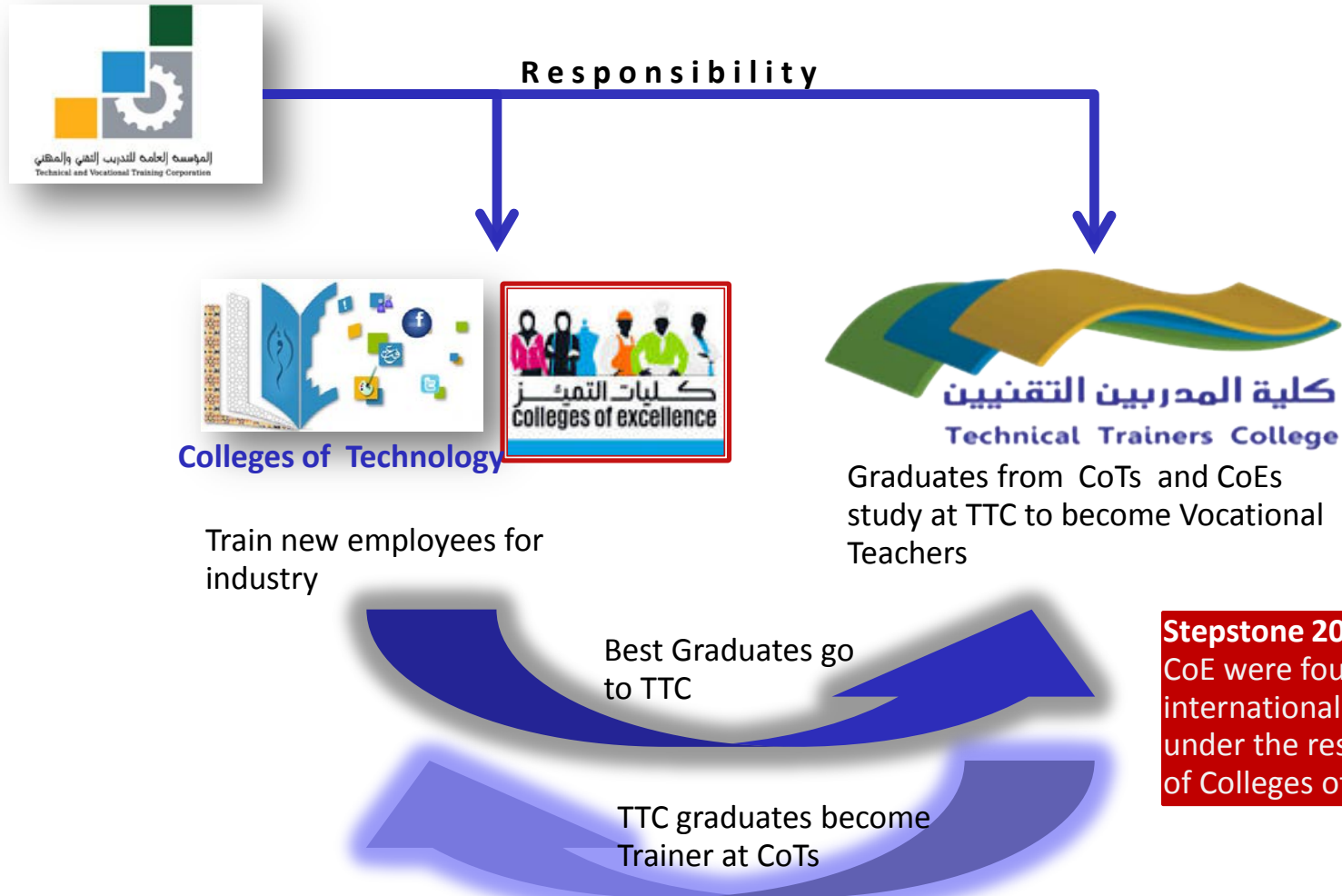

Content

- Saudi Arabian's Vocational Training System – Basics
- Changes in the System
- TTC's Hub Role

TTC is the only teacher training facility

- Only **TTC** offers training for future vocational teachers in the Kingdom of Saudi Arabia.
- **TTC** forms the model of vocational training in Saudi Arabia with a dual-approach combination of theory and practice
- **TTC** has the institutional experience for training in KSA and develops its curriculum continuously



What makes us unique:

- **One-phase training** which integrates Vocational Pedagogy with technical instruction
- Dynamic and **diverse faculty**, pedagogical experts as well as technical experts, ~ 25 Ph.D.
- **Action-oriented** teaching-learning methods
- One-shot educational experience, forming **K**nowledge, **S**kills and **A**ttitude (Herz, Hirn und Hand”)
- Integrated out-of-class experience :



40 % of Practical Training

Company Field Practice, Teaching Experience, Practical Courses

60 % Theoretical Training

Courses in the Vocational Disciplines

Courses in Vocational Pedagogy

CAT Yanbu – TTC's in-house Training Facility

- **College of Applied Technology** in Yanbu was founded in 2012 to train the best TTC's graduates in practical on-the-job teaching
- **CAT Yanbu** was designed as training facility closely attached to TTC to improve the teaching skills of Junior Trainers, graduates ofTTC



TTC in the wider KSA TVET System

- Establishment of additional courses according to CoE's development program
Next stepstone: February 2014
Automotive Engineering
- Build up of shared understanding between CoE's and CoT's Deans with TTC about curricular development
- Establishing evaluation program for TVET teachers in Saudi Arabia?
- Intercultural training for incoming international COE providers?
- Women's department at TTC?
- Initiation of a post-graduate degree for future school managers in *Educational (School) Management?*

شكرا

Thank you!

Visit us at www.ttcollege.edu.sa
or on our Campus in Riyadh





Back up

Bac.

How we got here

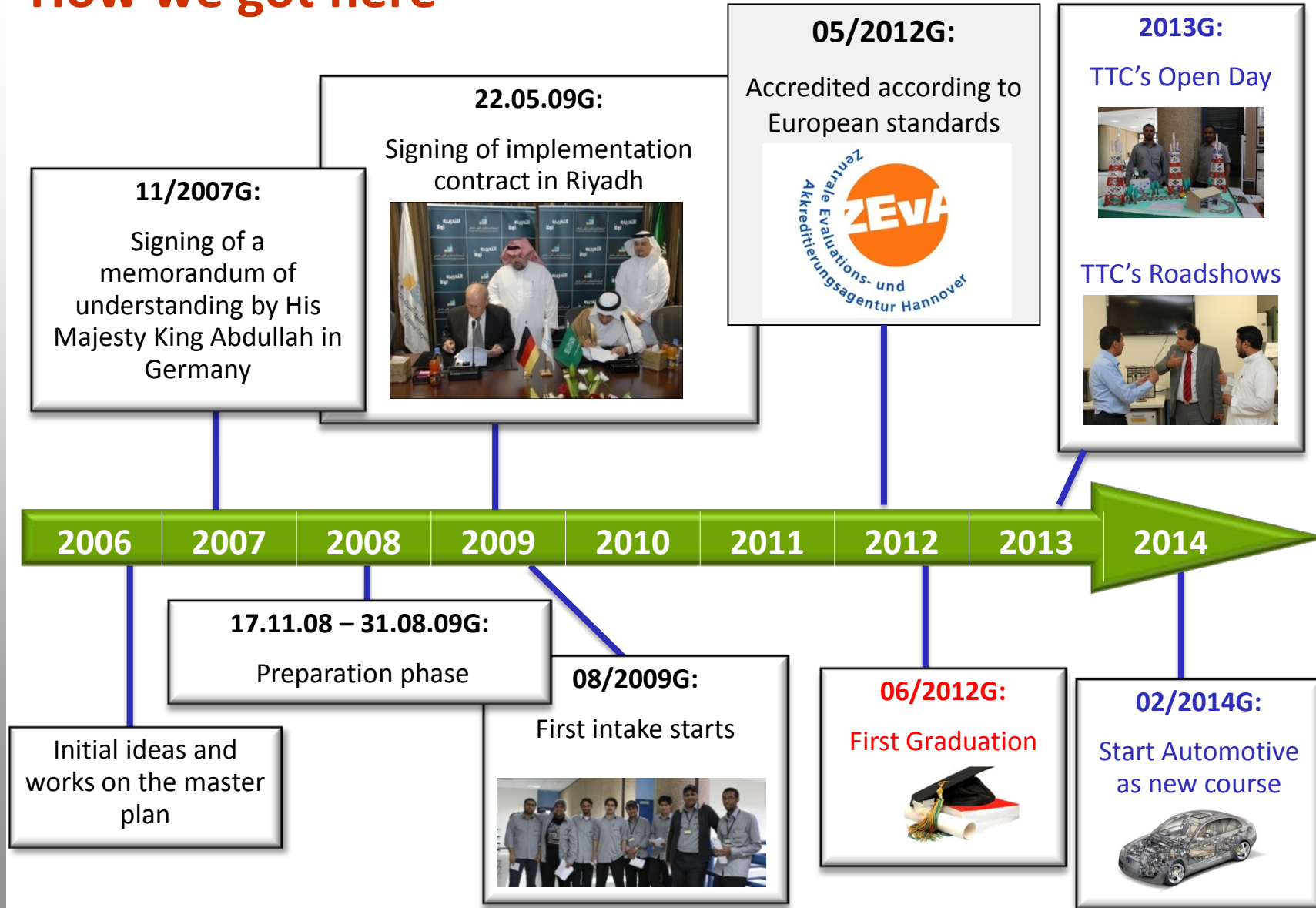

The German model: Theory and Practice

Practical insights and profound understanding of the conditions in today's globalized world of work

- Knowledge, Skills and Attitudes (K.S.A.)
- “Out of college learning opportunities”

Two periods of six weeks in Company Field Practice (CFP-1, CFP-2) during the summer break

Summer 2011: 420 trainees in CFP

Summer 2012: 642 trainees in CFP

Cooperative approach to build sustainable partnerships with companies all over the Kingdom of Saudi Arabia, including:



Zamil Industrial



الشركة السعودية للكهرباء
Saudi Electricity Company

TTC Academic Program

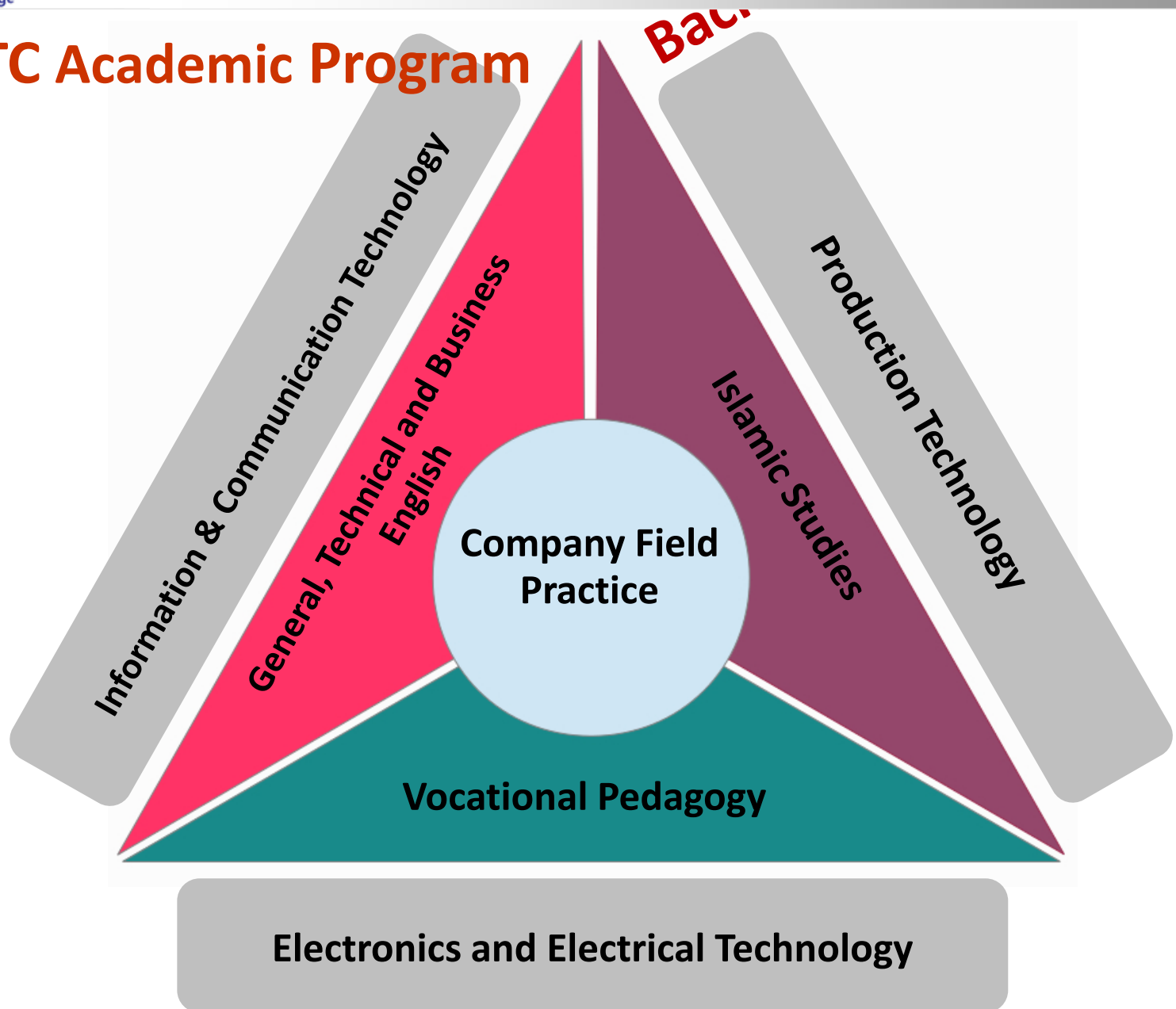

TTC programs

a. Mechanical Engineering

- Production Technology
- Refrigeration and Air Conditioning
- Automotive (*Start: Fall 2013*)

b. Electronics and Electrical Engineering

- Electrical Machines
- Electrical Power
- Electronics

c. Information and Communication Technology

- Telecommunication
- Application Development
- Network and System Administration

d. Islamic Studies

e. Vocational Pedagogy

f. English Language Training



Our Degree and our Graduate

- TTC offers a **Bachelor of Engineering Technology (BET)**
 - Combination of technical and vocational education
 - 240 Credit Points
 - 6 (8) semesters
 - English as main language of instruction

- Trainers at **Colleges of Technology (CoT)**
 - Existing CoTs
 - Foster Colleges
 - Colleges under foreign management



Back up

What makes us unique:

- **One-phase training** which integrates Vocational Pedagogy with technical instruction
- Dynamic and **diverse faculty**, pedagogical experts as well as technical experts, ~ 25 Ph.D.
- **Action-oriented** teaching-learning methods
- One-shot educational experience, forming **K**nowledge, **S**kills and **A**ttitude (Herz, Hirn und Hand”)
- Integrated out-of-class experience :



40 % of Practical Training

Company Field Practice, Teaching Experience, Practical Courses

60 % Theoretical Training

Courses in the Vocational Disciplines

Courses in Vocational Pedagogy

Back up

Student distribution according to disciplines

Production Technology	127
Refrigeration and AC	81
Electronics	127
Electrical Machines	87
Electrical Power	130
Network & System Administration	192
Telecommunication	84
Application Development	56

884

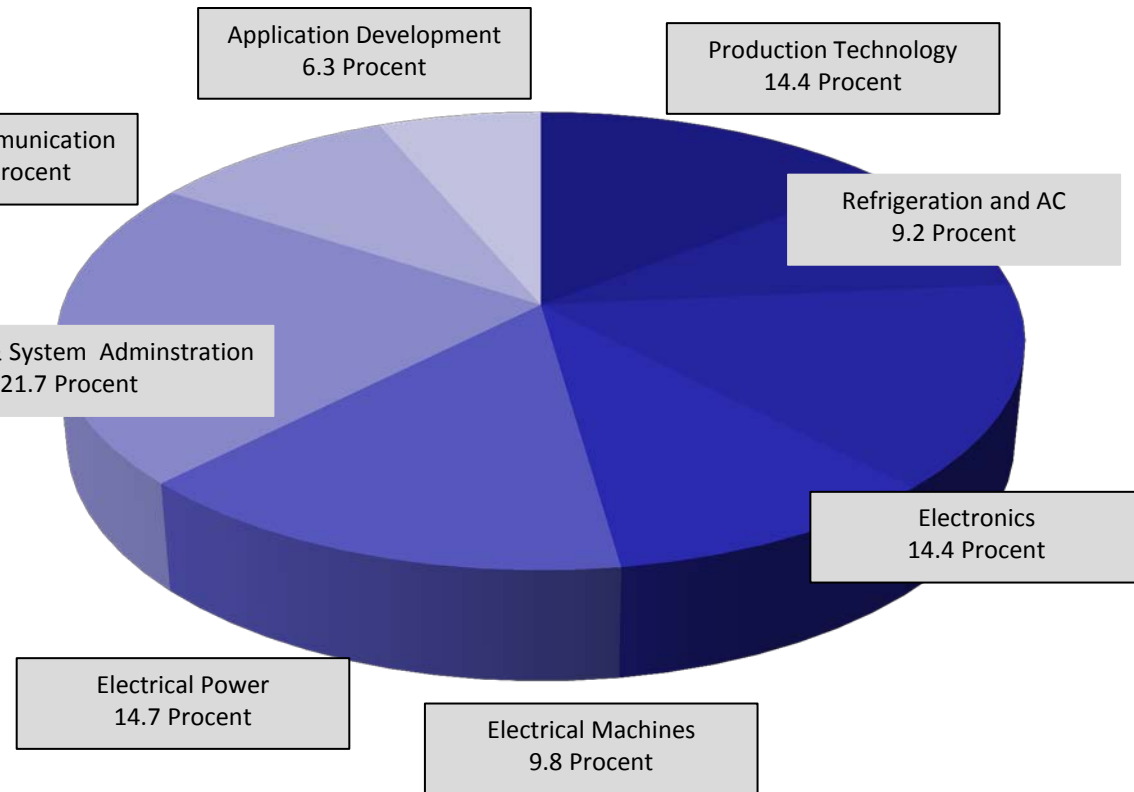

Currently more than 850 students our target - 1.200



Age: 22-28, Saudi nationals and Graduates of CoT



Back up

Student distribution according to semesters

1. Semester	186
2. Semester	137
3. Semester	115
4. Semester	129
5. Semester	144
6. Semester	165

884

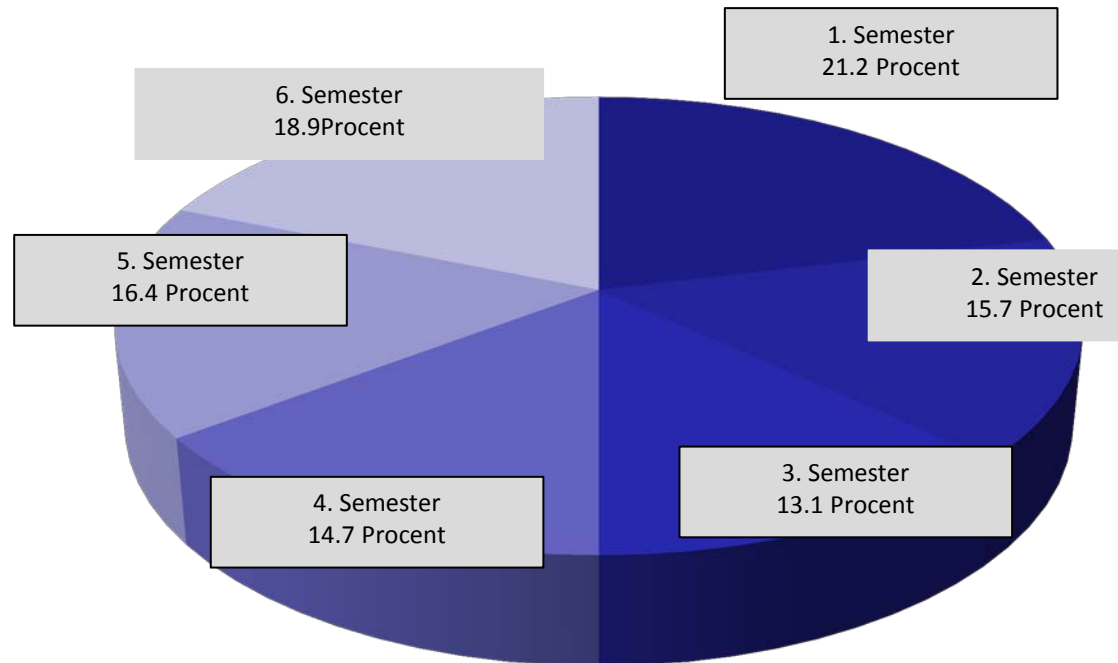

TTC Organization

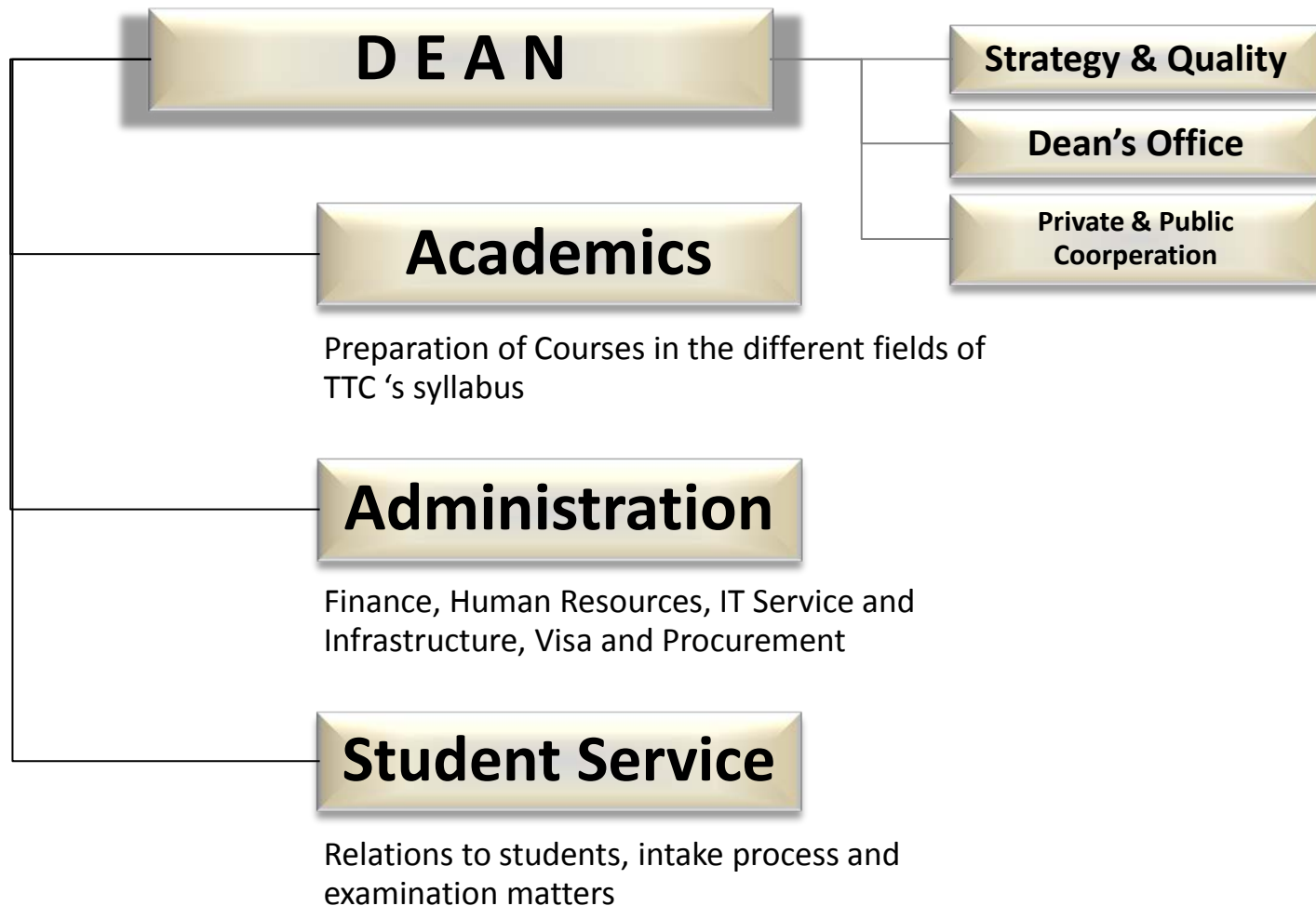

Positioning of TTC within GIZ

Back up

- TTC operates on an annual budget of currently SAR 90.000.000 corresponding to close to 20 Million € pa.
- TTC generates the single largest overhead for GIZ IS of any project with strict ZAS planning, monitoring and expenditure control.
- TTC is one of the few successful German international university projects. It is a project but also an institution.
- TTC is a growth venture, with replicable potential.
- GIZ IS employs at TTC currently **80** dispatched staff (“**Entsandte Mitarbeiter**”) Enormous, successfully mastered recruitment achievement
- Not all professional staff are “Entsandte Mitarbeiter”, but counting all contract types, TTC employs **140 professionals**.
- **23** faculty, staff and leadership personnel count with a **Ph.D.**
- There are in total 138 occupied positions.